

OWNER'S MANUAL



VF21BS

PORTABLE FIRE PUMP

No.003-12067-4

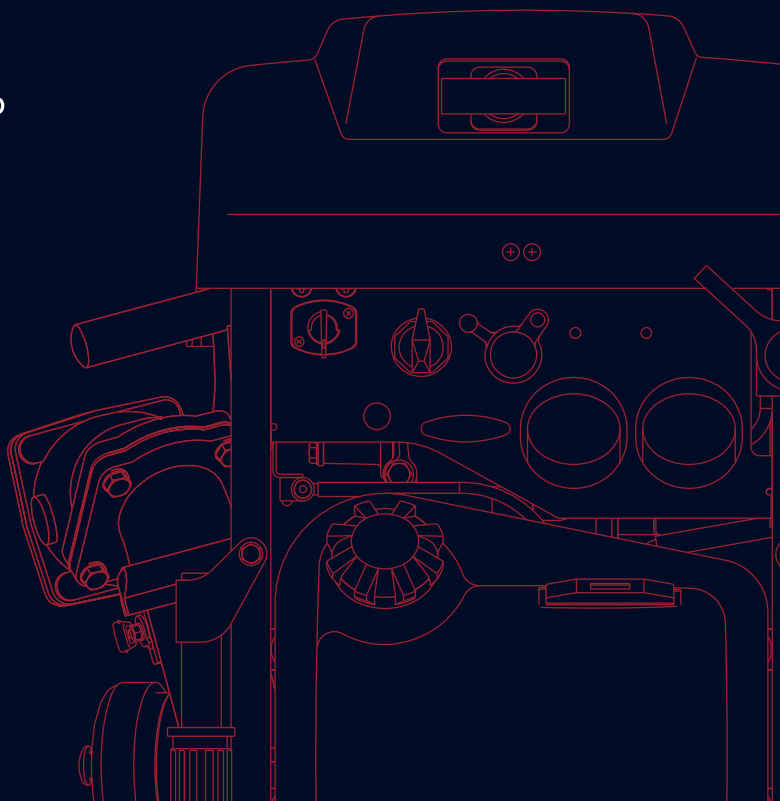

Copyright © 2023 Tohatsu Corporation. All rights reserved. No part of this manual may be reproduced or transmitted in any form or by any means without the express written permission of Tohatsu Corporation.

APPLICATIONS OF THIS FIRE PUMP

USAGE

TOHATSU portable fire pump “VF21BS” is manufactured for use in firefighting operations.

The portable fire pump is intended only for the firefighting activities in collaboration with general public fire extinguishing equipment.

Using it for other applications is regarded as being used for improper purposes.

The manufacturer of the fire pump bears no responsibility for any damage that may result from modification of the fire pump without prior permission from the manufacturer, improper use of the fire pump, or use of the fire pump for applications other than those stated above.

Note that use of the fire pump for applications other than the stated above can result in personal injury or damage to the equipment.

Using this fire pump within the range of intended uses implies that the user should follow the instructions provided by the manufacturer relevant to operation, servicing and maintenance.

Intended people

All persons who operate, service or maintain the fire pump must read and understand the following items:

- Owner's manual
- Safety-related instructions on the pump and the other parts such as the battery.
- The other owner's manuals, such as battery charger.

The portable fire pump should be operated by only persons who received training as operators of fire engines along with each country's (region's) regulations.

The range of personal responsibility and supervision must be strictly defined by the user.

If a person does not have adequate professional knowledge required for his/her assignment, he/she must undergo relevant training or receive appropriate instructions from an individual who is actually knowledgeable in operation of the fire pump.

A person who does not have enough knowledge is not permitted to operate the fire pump.

When using the fire pump, conditions under which an explosion may occur are not considered.



CAUTION

- **Keep this manual in a safe place for future reference.**
- **Operators of the fire pump must always refer to all the relevant manuals in order to avoid errors, personal injuries, and equipment damage when operating the portable fire pump, and to maintain faultless operation.**
- **Arrange owner's manual so that operators can refer to them where they operate the fire pump.**

INTRODUCTION

Thank you for purchasing the TOHATSU Fire Pump.

This fire pump has passed a range of quality assurance standards.

Owner's manual

The portable fire pump complies with relevant laws and regulations.

The manual includes a description for operation and maintenance. Before using this fire pump, be sure to read and understand the manual thoroughly.

Engine operation

This manual also includes a description for operation and maintenance of the engine.

NOTE

- The manual is an important item that goes with your portable fire pump.
- The manual should accompany this fire pump if sold to another person.

Before using this fire pump, write down the serial number in the following boxes. It will be useful in the case of asking about servicing, repairs and genuine parts.

Serial Number

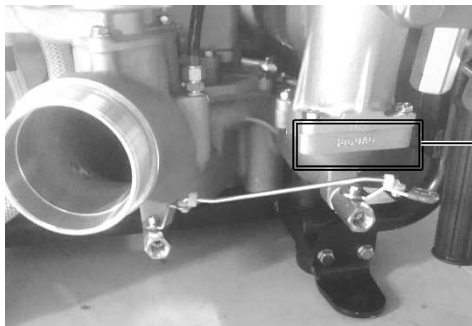

The pump serial (identification) number is marked on the pump casing.

--	--	--	--	--	--

GENERAL SAFETY INFORMATION

Overview

Before operating the TOHATSU fire pump thoroughly read this manual to understand the proper operating procedures including "DANGER", "WARNING", "CAUTION" and "NOTE".

These notices are designed to bring attention to very important information necessary to ensure safe, trouble free operation.



Warning sign

Meaning

This sign is used for safety-related instructions in this manual.

Be sure to follow all safety-related instructions, otherwise personal injury may occur.



Signal words



- Failure to observe will result in severe personal injury or death.



- Failure to observe could result in severe personal injury or death.



- Failure to observe could result in personal injury or property damage.

- This instruction provides special information to facilitate the use or maintenance of the pump or to clarify important points.
- For attaching position of the warning label, refer to the "CONTENT 3. LABELS".
- **Warning labels should be read clearly at any time. If the display of the warning label becomes difficult to be read or almost come off, you must replace the label pasted immediately.**

Safety-related instructions and warning signs

Read and follow the safety-related instructions described in this manual and all warning signs on the portable fire pump thoroughly.

Always keep the warning signs in a legible condition. If any warning sign becomes illegible or detached, replace it immediately.

Transporting the portable fire pump

CAUTION

- Retractable handle is folding type.
- Do not put hand or finger between top of retractable handle and bracket.
- When transporting the portable fire pump, assign one person per handle.
- Also, when you transport the portable fire pump, it should be transported holding the handle firmly.
- There is a risk of injury to the leg by fall.



Durability of protection

When you purchase a new pump, it is placed in packing box and protected.

Storage of pump after transportation

Keep the pump away from high humidity, and place it on a horizontal plane.

Disposal of packing box

Dispose the packing box by following the environmental laws.

Noise

CAUTION

- Wear proper hearing protection during operation.



Exhaust gas

Fatal hazard from carbon monoxide (CO) poisoning

Exhaust gas emitted from the engine contains carbon monoxide (CO) etc. that may seriously affect human health.

Do not operate the engine in a room, car, warehouse, tunnel or other closed locations that have poor ventilation.



Safety devices

Before operating this portable fire pump, be sure to check that all the safety devices have been installed in the appropriate positions.

Before removing the safety devices, turn the main switch off.



After protective devices (such as the muffler guard) have been disassembled as part of servicing and maintenance work, immediately install them back to their original locations, making sure that they are in safe and secure condition.



Check the portable fire pump visually and functionally on a regular basis.

If you find any faulty device or equipment, remove it immediately, and repair or replace it, if necessary. Failure to do so may cause an accident.

After it has been repaired or replaced, make sure that it functions correctly.



Protective clothing, Protective equipment

During fire extinguishing training or regular firefighting services, wear normal protective clothing and equipment to protect your body.

- Fireproof protective clothing
- Fireproof helmet
- Fireproof protective gloves
- Fireproof protective boots



Service, Maintenance

Servicing and maintenance of this fire pump must be carried out by only the persons who have professional knowledge, who are familiar with the device, and who understand laws and regulations regarding safety and accident prevention.

Before starting maintenance work, turn the main switch off to stop the engine.

Disconnect the negative terminal of the battery.

Before starting maintenance work, securely place the portable fire pump on the ground.

In the case of just after stopping the engine, do not touch the exhaust pipe, the muffler and the other engine parts until these parts will be cold enough. These parts could be very hot and will cause severe burns.



Electrical equipment

Only expert electricians or trained staff members should handle electrical equipment.

When disconnecting the cable from the battery, disconnect the negative (-) cable first.

When connecting the cable to the battery, be sure to connect the positive (+) cable first. After that, connect the negative (-) cable.

Do not place any metal on the top of or around the battery. Doing so may cause a short circuit.

Use a fuse with the same specifications as the original one when replacing it. Using a fuse that has a greater capacity than the rated value may damage the equipment.

While the engine is running, do not touch the high voltage ignition wire attached to the spark plug. The wire carries very high voltage will cause injury and body harm.

Check the electrical equipment of the fire pump on a regular basis.

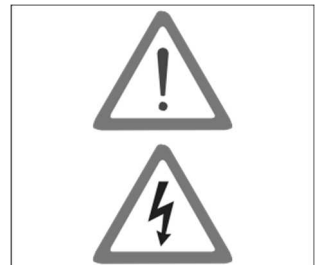
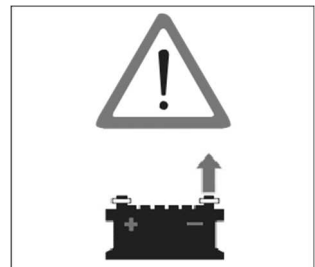

Battery

Follow any safety-related instructions shown on the battery.

The battery can generate flammable hydrogen gas that may **cause an explosion**.

Do not charge the battery in closed location.

Do not smoke around the battery.

The battery electrolyte is **caustic and may cause personal injuries**.

- Always wear protective clothing.
- Always wear protective gloves.
- Always wear protective glasses.
- Do not tilt the battery. Doing so may cause the battery electrolyte to leak out from the vent hole.



Handling of fuel

Exercise care when handling fuel. Failure to do so may cause fire.

Do not bring any flames near fuel. Stop the engine before refueling. Do not smoke while refueling fuel.

Do not refill fuel in an enclosed room. Doing so may cause an explosion caused by fuel fumes.

If fuel spills, wipe it with a cloth or other material, and dispose of it according to relevant laws and regulations.



Disposal

Dispose of disused batteries according to relevant laws and regulations.



Genuine parts

When replacing parts for servicing and maintenance of portable fire pumps, be sure to use only Tohatsu genuine parts.

If genuine Tohatsu parts and accessories are not used, it may adversely affect the functioning and safety of the fire pump. Use genuine Tohatsu parts only.

Tohatsu bears no responsibility for any personal injuries or equipment damage that may result from use of parts or accessories obtained from outside sources.

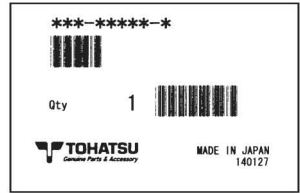

Environmental protection measures

Dispose of oil, fuel, batteries, etc. according to relevant environmental laws.

Do not dump waste into the ground, water, or sewerage.

Store the fuel only in the specified container.

When disposing of parts, follow the correct disposal procedure.

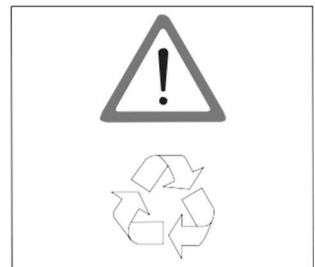

Water-prohibiting substance

Do not discharge water to water-prohibited substance.

Use of water

Do not pump combustible liquids, chemical or caustic liquids.

CONTENTS

1. SPECIFICATIONS.....	1
2. OPERATION DEVICE.....	4
3. LABELS.....	6
4. OPERATING PRECAUTIONS.....	7
5. DESCRIPTION OF DEVICES.....	9
6. PREPARATION FOR OPERATION.....	18
7. USE OF OPERATION PANEL.....	21
8. STARTING THE ENGINE.....	26
9. PRIME AND DISCHARGE.....	29
10. STOPPING THE ENGINE.....	36
11. MAINTENANCE AFTER OPERATION.....	37
12. MAINTENANCE IN COLD CONDITION.....	42
13. USE OF ACCESSORY.....	46
14. PERIODICAL INSPECTION.....	48
15. SERVICE AND MAINTENANCE.....	50
16. TROUBLESHOOTING.....	59
17. APPENDIX.....	63
18. TOOL AND STANDARD ACCESSORY.....	64

1. SPECIFICATIONS

Model		VF21BS
Description		Portable fire pump
Max. operating pressure		0.84 MPa (121.8 psi)
Usable ambient temperature		-20 °C ~ 40 °C (-4 °F ~104 °F)
Engine		
Manufacturer		TOHATSU CORPORATION
Model		2WF55A
Type		4-stroke, 2-cylinder, water cooled gasoline engine
Bore × Stroke		55 × 44 mm (2.17 × 1.73 inch)
Piston displacement		209 ml (12.7 cu.in.)
Authorized output		7.3 kW / 6250 r/min
Fuel type		Unleaded gasoline (RON 91 or Higher)
Fuel tank capacity		4 L (1.1 USG)
Fuel consumption		Approx. 3.1 L/hr (0.82 USG/hr) at 0.5 MPa 500 L/min (at 72.5 psi 132.1 GPM)
Choke system		Manual choke with fast idle
Ignition		Flywheel magneto (DIGITAL C.D.I. system)
Spark plug		NGK DCPR6E
Starting system		Electric starter and recoil
Lubrication		Wet sump
Engine oil		API: SH, SJ, SL SAE: 10W-30/40
Engine oil quantity		1.0 L (1.1 US qt.) when replacing oil filter: 1.1 L (1.2 US qt.)
Battery *1	Capacity	12 V-12 Ah/10 HR (180CCA)
	Dimensions (L x W x H)	135 x 80 x 160 mm (5.32 x 3.15 x 6.30 inch)
	Positive terminal	Right side
Floodlight bulb *2		12 V-55 W

*1 The battery is not shipped with the pump. Install a battery equivalent to this specification.

*2 Option

1. SPECIFICATIONS

Model	VF21BS
Primer	
Type	Rotary-vane vacuum pump (Oil less type)
Max. suction height	Approx. 9m (29.5ft)
Pump	
Type	Single suction, single stage, high pressure turbine pump
Transmission Ratio	1 : 1
Number of delivery outlets	1
Discharge port coupling	JIS 65mm (2-1/2"), NH 2-1/2" (65mm) male
Suction port coupling	JIS 65mm (2-1/2"), NH 2-1/2" (65mm) male
Pump performance (Suction height: 3m)	500 L/min at 0.6 MPa 250 L/min at 0.8 MPa 150 GPM at 75 psi 105 GPM at 100 psi
Dimensions and weight	
Length x Width x Height	480 × 596 × 560 mm (18.90 × 23.47 × 22.05 inch)
Mass (Dry)	49 kg/108 lbs (dry), 57 kg/126 lbs (ready for operation)

Materials

Engine	
Crankcase, Cylinder, Cylinder head	Aluminum alloy
Crankshaft	Chromium-molybdenum steel
Connecting rod	Chromium-molybdenum steel
Piston	Aluminum alloy
Pump shaft	Chromium-molybdenum steel with metal plating
Muffler	Steel/Stainless
Pump	
Pump casing, Pump cover	Aluminum alloy
Impeller	Aluminum alloy
Shaft seal	
Type	Mechanical seal

1. SPECIFICATIONS

Performance Curve VF21BS

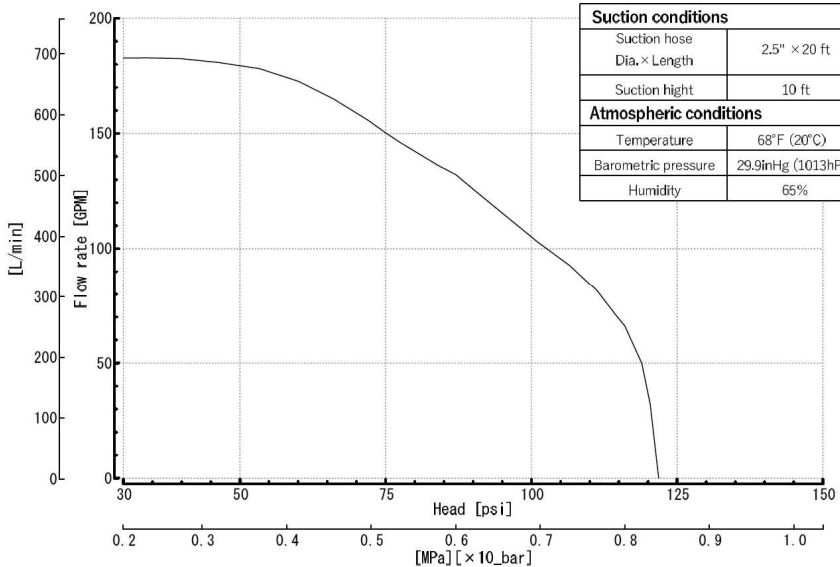
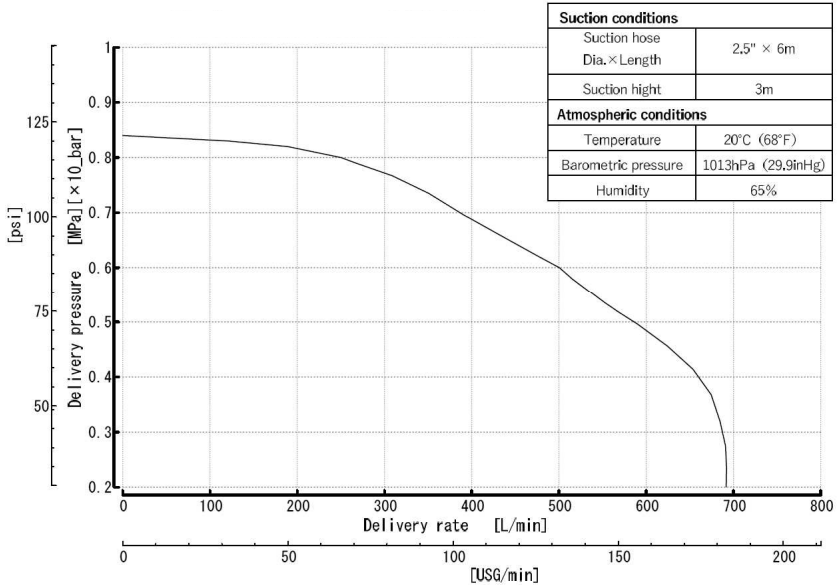

2. OPERATION DEVICE

Control panel and Battery side

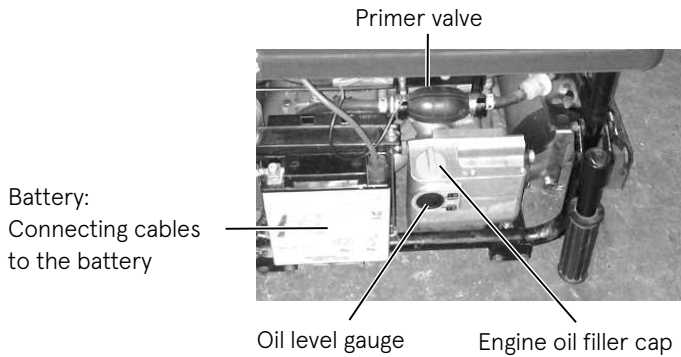
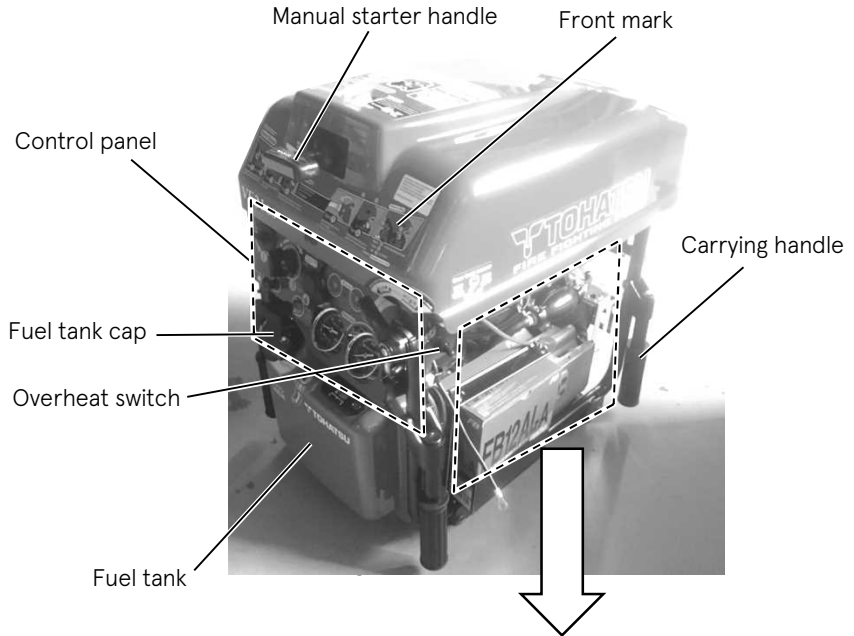

2. OPERATION DEVICE

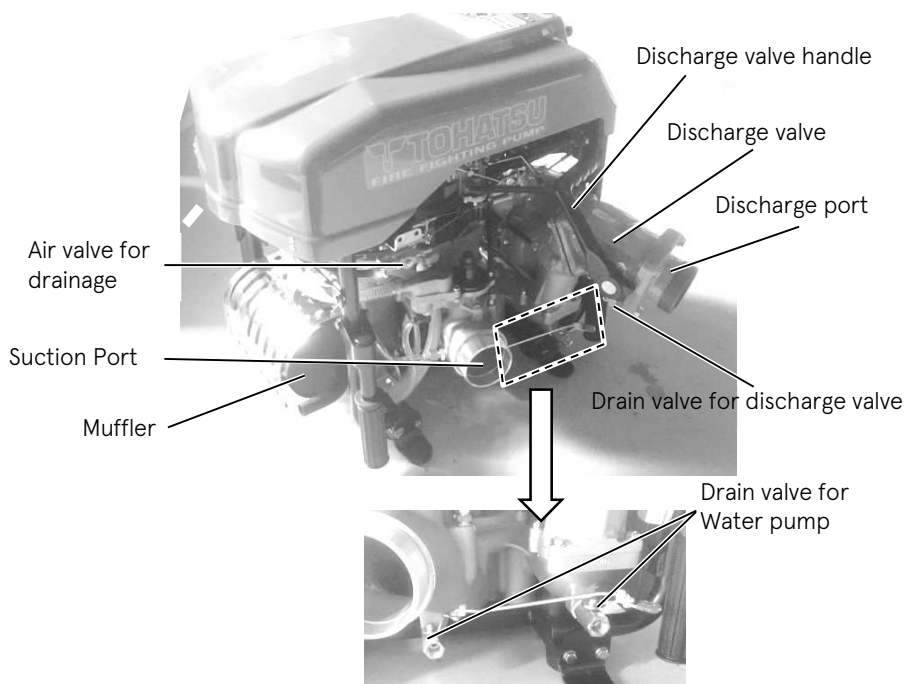
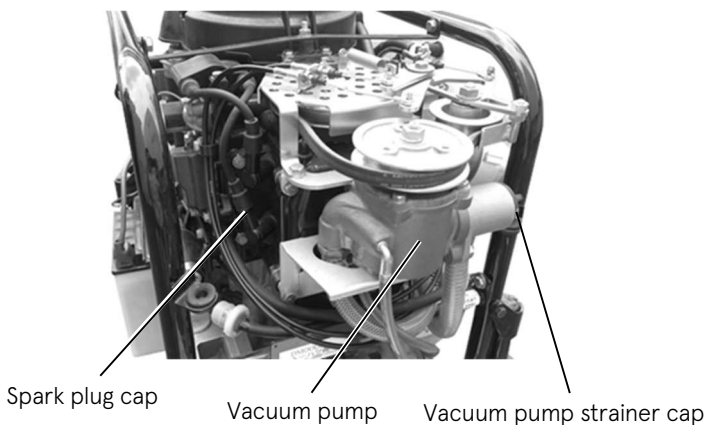

3. LABELS



Instruction label
Warning label
Caution label



Caution label (muffler)

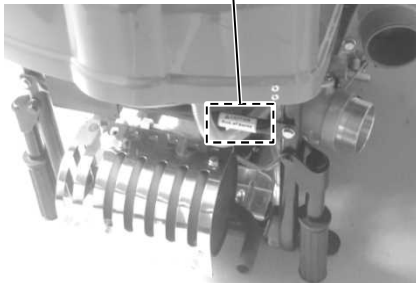

Warning label
Caution label



Caution label (battery)

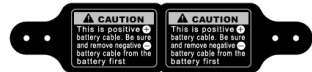

4. OPERATING PRECAUTIONS

Installing pump

 **CAUTION**

- **The fire pump must be installed on a level ground. Otherwise, an accident may occur. If the fire pump should be installed on an uneven ground, it must be secured.**

NOTE

- Place the pump as near as possible to water source, and water suction height as low as possible.
- When lowering the portable fire pump to the ground, lower it gently and horizontally.
- In case of the inclined location or uneven ground, make sure that the water suction hose is lower than the suction port of the pump.
- In case of the suction hose is put undulated, air can be left easily in the hose, and possibly causes suction inability when the water discharge valve is opened. In this case, set the water discharge valve half-opened, and operate vacuum pump until water is discharged continuously (for 3 to 5 seconds from beginning of water discharge).
- Be sure to install strainer and basket on the end of suction hose. If the pump may suck sand or mud on the bottom of water source, place sheet below the basket.
- Put the tip of the hose into the water more than 30cm (11.8in) deep from the surface to prevent air suction.
- Discharge hose should be arranged not to be bent.

4. OPERATING PRECAUTIONS

CAUTION

- When installing the portable pump in a vehicle, place the vehicle on a level place, and install the pump.
- When installing the portable pump, in the vehicle, make sure to apply the brakes of the vehicle in order to stop the wheels. A serious accident may occur if the vehicle moves.
- Do not put your hands or fingers in the retractable part when operating the handle.
- When transporting the portable fire pump, assign one person per handle. Also, when you transport the portable fire pump it should be transported holding the handle firmly to avoid falling down the pump.

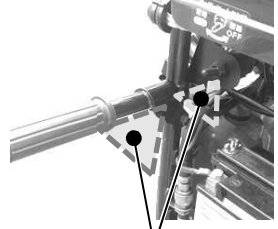

Do not put your hands or fingers

NOTE

- When lowering the portable fire pump to the ground, lower it gently and horizontally.
- Do not touch the exhaust pipe and the muffler while the engine is running, or for more than 10 minutes after the engine has been stopped. These parts are very hot and will cause severe burns.



5. DESCRIPTION OF DEVICES

Carrying handle

The fire pump is equipped with for carrying handles. The handles can be manually folded, and opened by rotating them by 90 degrees.



- **Personal injuries may occur when opening or closing the handle.**
- **Do not put your hands or fingers into the retractable part when operating the handle.**
- **To prevent injuries, two persons should work together when carrying and placing the pump.**



Carrying handle



Opening cowl

1. When removing or attaching top cowl, turn the throttle lever to "High pressure" side.



Throttle lever

2. Remove the rear hooks from the holes, and remove the top cowl while taking care not to give damage with the recoil starter handle.

NOTE

- It is necessary to remove the top cowl to remove the spark plug.

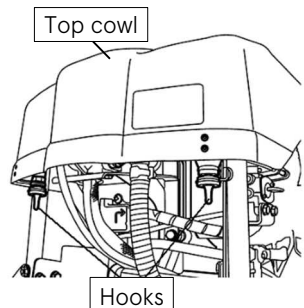

5. DESCRIPTION OF DEVICES

Assembling cowl

After putting recoil starter handle through top cowl hole, put front latch into hole of control panel, and then, fit the rear hook into the hole.

NOTE

- Pay attention to have the starter handle for manual starting goes through the window at the front upper side of the cowl.

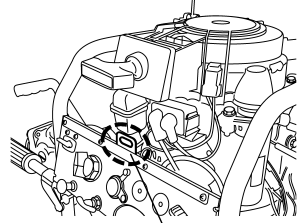

Latch mounting hole

Suction port

The diameter of the thread for fire pump

- JIS 65 mm
- NH 2-1/2"

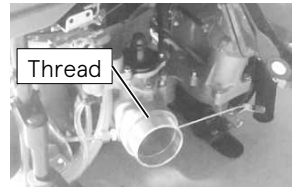

⚠ WARNING

- When the pump is run while the strainer is not installed, if you insert your finger into the suction port, you may be seriously injured by the rotating inducer.



⚠ CAUTION

- A strainer must be installed at the suction port.
- Do not run the pump if the strainer is not installed.
- If the pump is run when the strainer is not installed, gravel may enter the pump, resulting in significantly reduced water discharge capacity.

5. DESCRIPTION OF DEVICES

Discharge port

The diameter of the thread for fire pump

- JIS 65 mm
- NH 2-1/2"

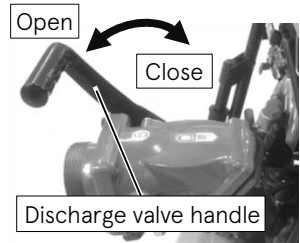

Discharge valve

Use discharge valve handle for opening and closing the discharge valves.

Drain valve

Use the drain valves to drain water.
(4-unit, operate at three locations.)

Drain valves:

- at the pump case
- at the ball cock discharge valves and the valve for drain from the engine.

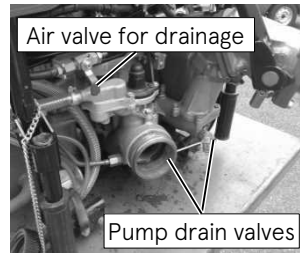

NOTE

- Close all the valves when operating the fire pump.
- If a valve is opened, water cannot be suctioned.



Fuel tank

Refill appropriate amount of gasoline to the fuel tank.
Close the fuel tank cap all the time except refuel.



- **If the fuel leaks, wipe it off using a cloth or other materials.**



5. DESCRIPTION OF DEVICES

Engine oil

Refill appropriate amount of oil to the oil pan.
Close the oil filler cap all the time except filling.

Recommended engine oil :

4-stroke engine oil

API: SH, SJ, SL

SAE: 10W-30/40

0W-30 is recommended for operation in cold regions. (10°C or below)

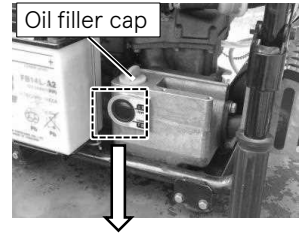

Control panel

The control panel is equipped with all the necessary operating and control instruments as follows.

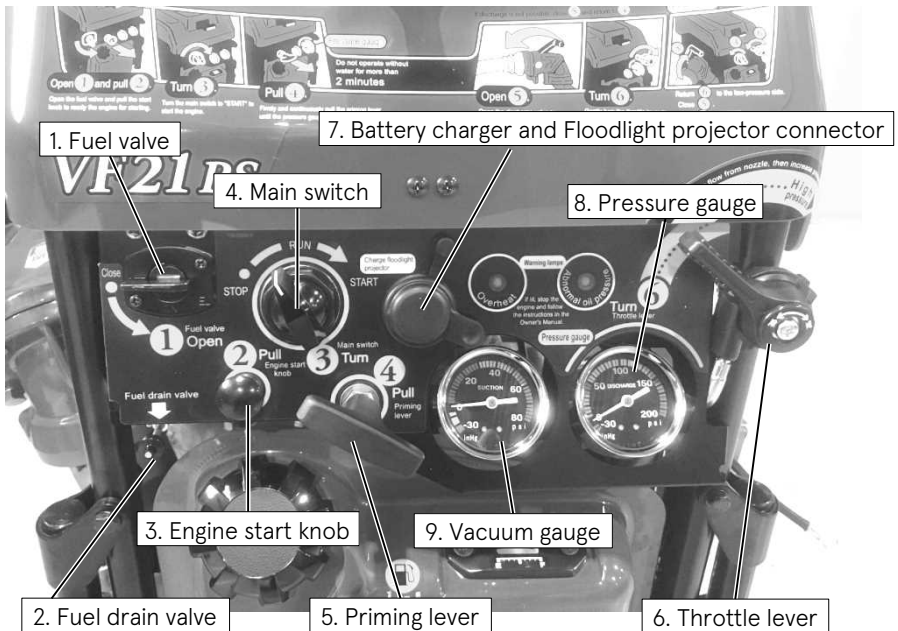

5. DESCRIPTION OF DEVICES

1. Fuel valve

Turn the fuel valve to control the fuel supply by full open or close completely.

2. Fuel drain valve

Before storing the pump long term, drain the fuel from the carburetor.

3. Engine start knob

Pull the engine start knob.

4. Main switch

Turn the main switch to run or stop the pump for VF21BS.

Description	Function
OFF	To Stop the pump
ON	Running position
START	To start the pump running

5. Priming lever

Used for suctioning water.

After starting the engine, pull the priming lever to suction water, after priming has been completed, return the priming lever to the original position.

6. Throttle lever

Use the throttle lever to control discharge pressure.

It shows the throttle position such as engine start and priming water position.

7. Battery charger connector

When charging the pump battery, connect the charger plug to the connector.

<Specifications of accessory socket>

- Voltage : DC12V
- Max, allowable current : 5A

8. Pressure gauge for discharge

The pressure gauge for discharge indicates the actual operating pressure.

9. Pressure gauge for suction

The pressure gauge for suction indicates the input pressure supplied from an external water source.

5. DESCRIPTION OF DEVICES

Initial charge of battery

The battery can be used immediately after filling cells with electrolyte.
Be sure not to open the battery after filling it with electrolyte.
Refer to the instruction of the battery.



CAUTION

- **Before charging the battery, turn the main switch OFF.**
- **When starting the pump operation, be sure to remove the battery charger plug from the connector before turning the main switch ON.**
- **The connector is for a battery and a floodlight.**
- **Do not connect a cigarette lighter to the connector, because it is not a heat resistant object.**

Fuse box

Security fuse is installed for electrical circuit in the fuse box.

Fuse is in the yellow color fuse box

*Fuse : 7.5A

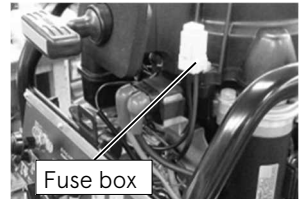

Manual starter

If the engine does not start with the starter motor, use the manual starter.

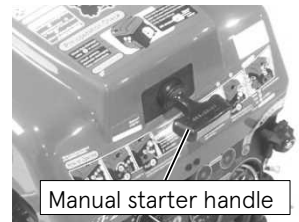

CAUTION

- **Personal injuries may occur.**
- **When you start the engine using the manual starter, pull the starter handle in a breath when you feel the handle heavier.**
- **Do not pull the manual starter handle when the pump is running. Otherwise, the manual starter may be damaged.**
- **In case engine will not start due to lack of fuel, squeeze primer bulb several time, and try starting again.**
- **Install the battery to start the engine and operate the pump, even if the battery is insufficient charged. If the battery is not installed and not connected, the electrical equipment may malfunction.**

5. DESCRIPTION OF DEVICES

Warning lamp and buzzer

Turning the main switch to "RUN" position, the lamp and buzzer check mode starts. The warning lamps light up and the buzzer sound for a moment to enable to check those functions. In the case of manual starting, while pulling the recoil starter the lamps and buzzer sound for a moment.

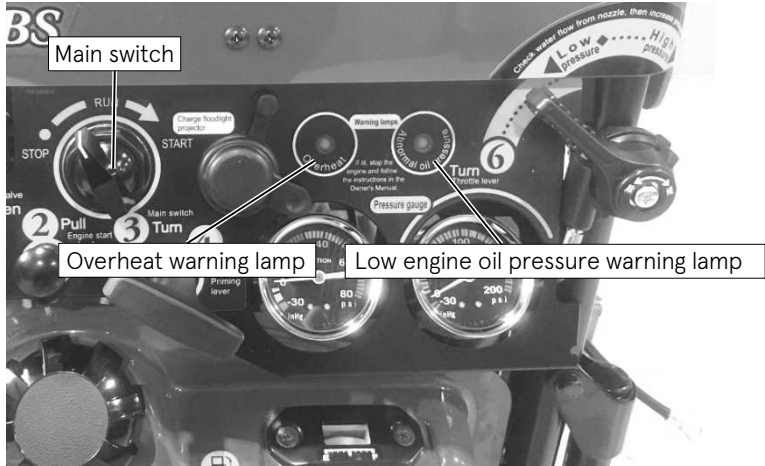

- If they do not, remove the cause by following the cause by following the "16 TROUBLESHOOTING" section.

The monitor shows the following information:

- Overheat warning
- Low engine oil pressure warning

Overheat warning

If overheat is detected, overheat lamp lights up, the warning buzzer sounds and the engine stops automatically.

NOTE

- The engine stops automatically when overheat is detected.



- **The engine may be damaged.**
- **Do not restart the engine soon after it has stopped running.**

5. DESCRIPTION OF DEVICES

Low engine oil pressure warning

Check engine oil level, and replenish if it is lower than specified level. If the level is within specified range, consult the dealer.

CAUTION

- **The engine does not stop even if the low engine oil pressure warning lamp lights up. This is to give priority to the continuation of fire fighting over protection of the engine.**
- **The engine remains operational for more than 30 minutes even after the warning lamp lights up.**
- **However, if the engine is operated for longer than this, it may seize. Refill oil immediately.**

Recommended engine oil :

4-stroke engine oil

API: SH, SJ, SL

SAE: 10W-30/40

0W-30 is recommended for operation in cold regions. (10°C or below)

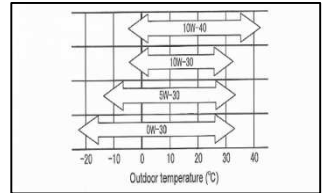

For operation in cold weather (10°C below or less), 0W-30 is recommender.

Please refer to the following table to select oil with viscosity suited to outdoor temperature of the site.

If the oil level is near the lower limit, replenish the oil until the upper level. Do not fill the oil over the upper limit. (Be sure to check oil level before starting engine.)

CAUTION

- **If the engine oil is found cloudy or very dirty, consult the dealer.**
- **Do not use engine oil by mixing different brand or grade products.**
- **When refilling engine oil, please be careful not to get dirt and water into the engine.**
- **If engine oil is spilt, wipe out completely with cloth.**

NOTE

- For replacement of engine oil, refer to “Chapter 11. MAINTENANCE AFTER OPERATION”.

5. DESCRIPTION OF DEVICES

Floodlight (Search light) *Option

Use the floodlight projector to light up the location where this fire pump is operated.

Connect the floodlight plug to the connector of the pump.

Fix the projector to the tripod with tightening the adjust screw.

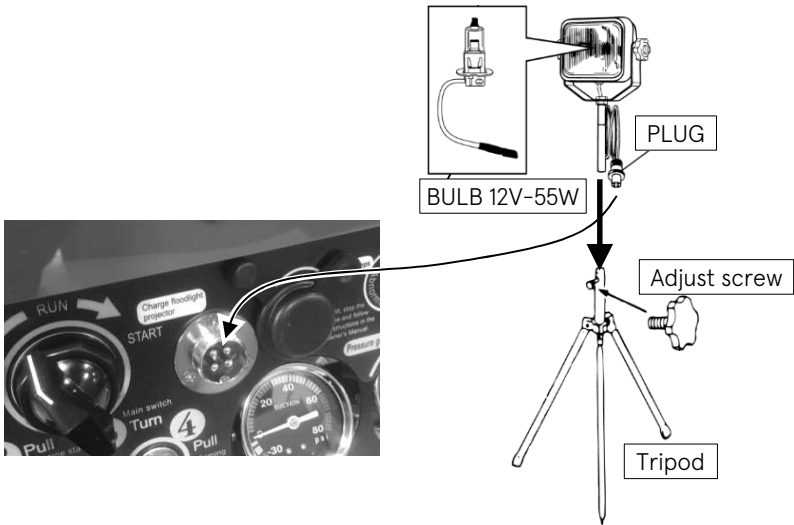

- Secure adequate lighting for the location where the fire pump works, otherwise an accident may occur.

6. PREPARATION FOR OPERATION

Installing battery

Install the battery in the pump. Secure the battery with the battery terminals facing outward.

CAUTION • Refer to the contents "13. USE OF ACCESSORY Battery".

Initial charge of battery

The battery can be used immediately after filling cells with electrolyte.

If the battery is maintenance free of electrode (Sealed type battery), do not open the battery after filling it with electrolyte.

Refer to the INSTRUCTIONS of the battery.

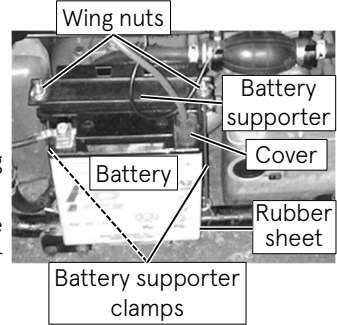

Fuel

Fill the tank with gasoline until the maximum level which is indicated by the gauge indicator (red).

DANGER • Vaporized fuel may cause ignition or an explosion.

- Do not bring any flames near fuel.
- Stop the engine before refueling or draining fuel from carburetor.

CAUTION

- Do not spill fuel or overfill fuel into the tank.
- Do not breathe in the Petrol vapor! Petrol fumes are very toxic.
- After stopping the engine, do not touch it while it is hot.
- Refill fuel after the engine has cooled down.
- Close the fuel tank cap tightly.
- Remove the fuel tank cap and filling fuel into the tank. Do not spill the fuel. If there is spilled fuel, properly clean up all the fuel spills (checking for gasoline vapor) before starting engine.
- If petrol or fuel spills, wipe it off using a cloth or other materials, and dispose of them according to the relevant laws and regulations.



6. PREPARATION FOR OPERATION

NOTE

- Use of low-quality fuel results in a short engine life as well as starting difficulty and other engine problems.
- Fuel containing alcohol, methanol (methyl), or ethanol (ethyl) may cause:
 - Deterioration of rubber parts and plastic parts.
 - Starting, idling and other engine performance problems.
- Do not use fuel containing over 10% ethanol. Do not use fuel containing over 5% methanol.
- Damages resulting from the use of fuel that contain alcohol are not covered under the limited warranty.
- Always fill the fuel tank with gasoline to be ready.

Engine oil

Before using the pump, fill it with the designated amount of engine oil.

Fill the engine oil until "upper" level.

CAUTION

- **If the engine oil is not enough filled, the warning buzzer sounds.**
- **Always wipe off spilled engine oil.**

NOTE

- If the engine oil is not enough (Less than approx. 1/3 of the oil tank), the warning lamp for oil level lights on, and the warning buzzer sounds.
- If oil becomes cloudy white, or it is dirty, please consult with your local sales representative.
- For more information about engine oil change, see the section how to change the engine oil.

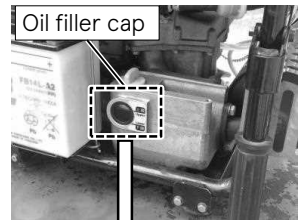

6. PREPARATION FOR OPERATION

4-stroke engine oil

API: SH, SJ, SL

SAE: 10W-30/40

Drain valves

Make sure all drain valves are closed.

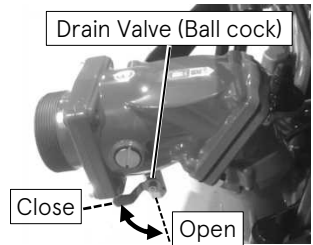
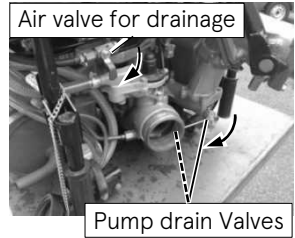

Discharge valve

Close the discharge valve and the drain valve.

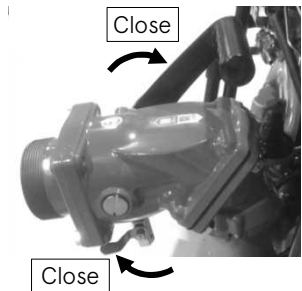

NOTE

- After determining the direction of the discharge valve, tighten the positioning (lock) bolt, to keep the direction of the valve.
- Do not change the direction of the water discharge valve when the lock bolt is being fixed (being tightened).

7. USE OF OPERATION PANEL

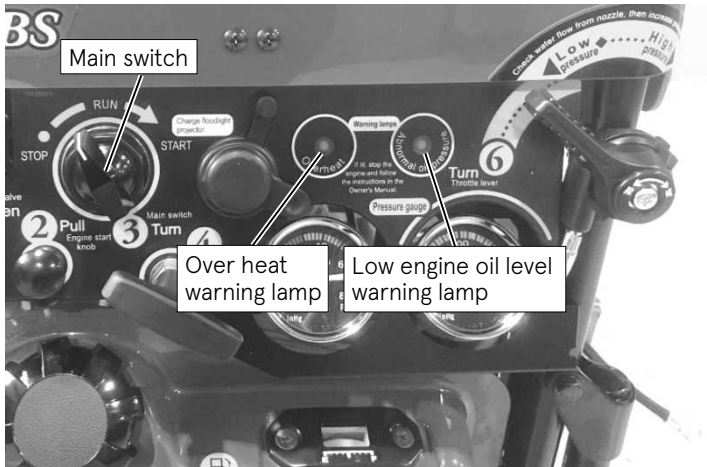

Overheat warning lamp

When the cooling water temperature rises above about 90 ° C, the engine shuts off automatically to prevent overheating.

Warning lamp and sensor

Turning the main switch to the “RUN” position, warning lamps turn on and the buzzer sound for a moment. (“Lamp check”)

⚠ CAUTION

- **After the engine has stopped due to over- heating, if you restart the engine immediately, engine may be burnt.**
- **Before restarting the engine, eliminate the cause (refer to “Chapter 16 TROUBLESHOOTING”). Also, check that the warning lamps are turned off.**

7. USE OF OPERATION PANEL

Warning system

If any abnormality occur in the engine or the pump, an alarm buzzer sounds and the corresponding warning lamp turns on or flashes, and the engine will stop or the speed will be controlled which is depending on the status of an abnormal phenomenon.

Alarm Displays, Abnormal Phenomena and Actions

Abnormality	Indication			Speed control			Description	Action (See next Panel)
	Lamp		Buzzer	ESG		Engine stop		
	Abnormal hydraulic pressure	Engine over heating		High speed	Low speed			
Lamp & Buzzer check	Flashing	Flashing	Beep once				No abnormality, System operation check at Main switch ON (Electric starter model only)	
Over revolution				○			6250 r/min in case of Over-revolution.	A
Low hydraulic pressure	Light on		Continuous sound		○		Controls engine speed to less than 3000 r/min, in case of abnormally low hydraulic pressure.	B
Engine overheating		Light on	Continuous sound			○	Activates engine stop control in case of engine overheating.	C
Overheat sensor switch at "OFF"			Continuous sound				In the case of overheat switch is OFF, it notifies with buzzer sound.	D

*ESG: Electrical Safety Governor

7. USE OF OPERATION PANEL

Actions to be taken

- A : Turn the throttle lever to low pressure side. Water may not to be kept in the pump.
- B : Check the engine oil level, and replenish the oil if it is lower than specified level. If the level is within the specified range, contact the dealer.
- C : After removing the cause of cooling water shortage, set the overheat sensor switch "OFF" and start engine again.
After checking that the lamp goes out, turn the overheat switch "ON".
- D : Keep the overheat sensor switch "ON" side.

7. USE OF OPERATION PANEL

Pump installation

⚠ WARNING

- Since the temperature around the engine becomes high because of the muffler and exhaust gas, install the pump on level ground at least three meters away from inflammable materials including dead leaves and wood.
- Exhaust gas, which contains carbon monoxide, is a deadly poisonous gas with no color and no smell.
- Do not operate engine in a closed space or an insufficient ventilation place such as indoor, in the vehicle, warehouse, tunnel, well, in the hold of a ship.
- Do not start the engine with water discharge valve open.
- Do not pump up and discharge liquids other than water (e.g. flammable liquids or chemicals).
- The pump is designed as a water pump only.
- Do not discharge water to water prohibited substance.
- Do not run the pump without suction port strainer.
- If you insert your hand into the suction port, you may be seriously injured by the rotating inducer.



7. USE OF OPERATION PANEL



- **Do not run the pump without suction port strainer. If gravel enters the pump, then the pump could be damaged and the performance would be significantly reduced.**

1. Place the pump in a horizontal location and close to the water source. Ensuring it is in a stable position.
2. Connect suction hose and delivery hose to the pump securely. Put the end of suction hose in water source. The suction hose must have a strainer and a basket (filter).

Starting engine



- **Wear proper hearing protection during operation.**



- While the engine is running, never touch the high voltage ignition wire attached to the spark plug.



- Very high voltage flow on the wire on each, causing injury and damage to the body.

- Do not operate the pump on dry grass. The exhaust system will be very hot and could cause the dry grass burnt and fire. Clear the area if necessary.

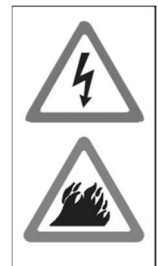

8. STARTING THE ENGINE

Make sure that the discharge valve is closed.

Operate the pump according to the operating procedure (along with the order shown on the machine).

If the throttle lever cannot be kept after the engine is started, adjust the throttle lever as below. (① ~ ④).

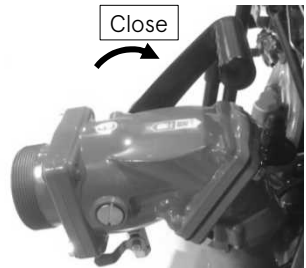

Adjustment procedure

- ① Connect the suction hose to the pump.
- ② Start the engine and suck up water.
- ③ After sucking water, set the throttle lever to "High pressure" position with the discharge valve closed.

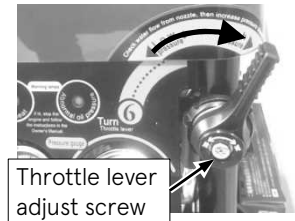

CAUTION • To avoid overheating, do the operation with the water sucked up condition.

- ④ Tighten throttle lever adjustment screw until the throttle lever can be kept at "High pressure" position.

CAUTION • Do not over tightening throttle lever adjustment screw. The throttle lever may be broken

- ⑤ After adjusted, return the throttle lever to the "Low pressure" position.
Drain water from the drain cocks.
(Refer to "Chapter 11 MAINTENANCE AFTER OPERATION")

8. STARTING THE ENGINE

1. Turn the fuel valve to the open position, this will allow fuel to flow into the carburetor.

If the fuel line runs short of fuel and cannot be started, grasp primer valve several times until the primer valve becomes hard.

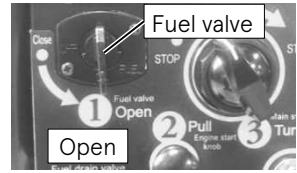

2. Turn the main switch to RUN position and pull the engine start knob.

If continuing to drive for more than 1 minute while pulling the start knob, the engine may stop due to excessive fuel supply.

In this case, do not pull the start knob and restart it.

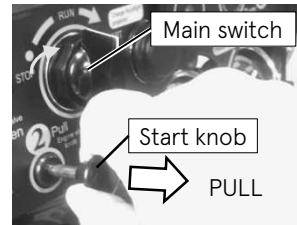

3. Check the throttle dial position.

If the temperature is 0 ° C or less, turn the throttle lever some times between the high pressure side and the low pressure side. About twice at 0 ° C, 5 times at -25° C.

Set the lever at "◆" mark.

If the ambient temperature exceeds 0 ° C, set the throttle at the low pressure side.

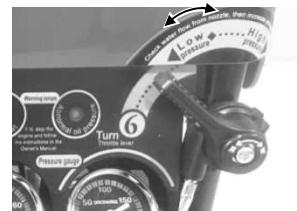

4. Turn the main switch to the " START " position. Release the main switch immediately after the engine started.



NOTE

- Extended operation of the starter motor will run the battery drain. Operate the starter motor for maximum 3 seconds.
- If the engine does not start, then wait for 5 seconds before operating the starter motor again.
- Do not operate the starter motor after engine started. If the starter motor does not work, check that the battery terminals are tightly connected and the battery is fully charged.

8. STARTING THE ENGINE

Starting engine using the manual starter

If electric starter does not work, use the manual starter.

Start the engine by pulling the handle from the position where it feels heavy.

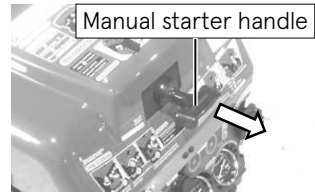

⚠ CAUTION

- **Install the battery to start the engine and operate the pump, even if the battery is insufficient charged. If the battery is not installed and not connected, the electrical equipment may malfunction.**

NOTE

- In case engine will not start due to lack of fuel, squeeze primer bulb several times, and try starting again.
- Keep the operating time of the vacuum pump within 30 seconds.
- If suction cannot be done within 30 seconds, there is the other problem.

Dry operation

This portable pump has outsource cooling system, limit the duration of dry operation so that it is within the following time periods.

Performing dry operation longer than the specified time period may cause damage to the engine or pump.

- Throttle lever at idle position: Within 2 minutes
- Throttle lever at “◆” position: Within 30 seconds

Closed discharge valves operation after priming water

When the pump runs with the discharge valve closed, the cooling water temperature becomes high.

⚠ WARNING

- **Do not run the engine with opened recoil starter to avoid serious injury.**

⚠ CAUTION

- **Run the pump with the closed discharge valve, the pump will be overheated.**

9. PRIME AND DISCHARGE

Prime and discharge

⚠ WARNING

- While the engine is running with the cowl removed, do not touch the rotating parts of the pulley or belt.

This may cause personal injuries.

**NOTE**

- If, when operating the vacuum pump for 30 seconds, the pump does not suck water or if water drop out of the pump during the water discharge operation, check the following:
 - Is the tip of the suction hose completely below the water surface?
 - Is air sucked through the joint of the suction hose?
 - Is the suction hose damaged?
 - Does the vacuum performance of the priming pump reduce significantly?
 - Does the pump case leak vacuum?
 - Does a vacuum leak occur when the pump is connected with the suction hose of which the opening is capped?

Refer to “Chapter 16 TROUBLESHOOTING”.

1. After the engine starts, pull the priming lever.

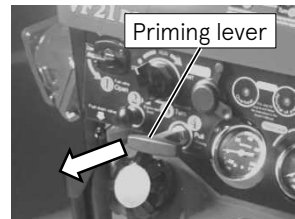

2. Check that the pumped water is discharged continuously from the priming outlet of the vacuum pump.
Be sure the pressure gauge shows positive side.

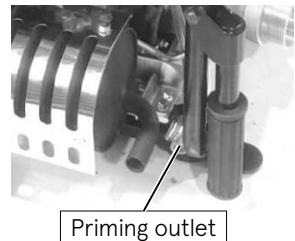

9. PRIME AND DISCHARGE

3. Return the priming lever to the original position.

NOTE

- Limit the vacuum pump operating time to within 30 seconds.
- If the pump can't suction water within 30 seconds, it may have a problem. Refer to "Chapter 16 TROUBLESHOOTING" to rectify the problem.
- When priming water from a water source that is considerably lower location than the pump, suction may fail to bring water up to the pump.
- If the pump runs with no discharge water for more than 2 minutes (If it's at low speed), the pump may have damages. The pump should be run with water discharge for protecting some parts of the pump such as mechanical seal by cooling water (discharge water).

4. Turn the handle slowly to open the discharge valve as shown in the picture.

The discharge valve handle can be turned approximately 90 degrees.

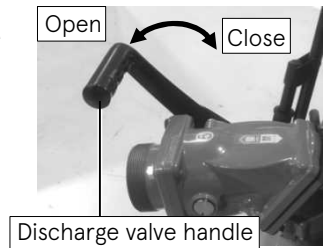

CAUTION

- **Before opening water discharge valve of the pump, be sure to warn the person holding the nozzle, and confirm to be ready to discharge water.**
- **During operation, check the suction and discharge hoses.**
- **The hoses must be free of kinks, pinches, etc., possibly caused from emergency vehicles rolling over the hose.**

NOTE

- To avoid the air left in the hose, the pump should be located above the suction hose. If some air left in the hose, the pump may not be able to discharge the water by the accumulated air in the hose when you open the discharge valve. In this case, open the discharge valve and operate the vacuum pump for 3 to 5 seconds more until the water is continuously discharged.

9. PRIME AND DISCHARGE

5. Adjust the water volume and pressure turning the throttle lever.



⚠ CAUTION

- In the case of using a branch pipe, the person holding the branch pipe must be notified of changes in water discharge pressure caused from engine speed changes or discharge valve setting changes.
- Discharged water should not be directed toward people under any circumstances.
- Do not look into the nozzle opening at any time.
- Do not put fingers or hands into the discharge nozzle.

9. PRIME AND DISCHARGE

Relay water supply (when water is supplied from a fire hydrant)

1. Determine the pump pressure in consideration of the water discharge pressure (nozzle pressure), hose pressure loss, and height loss.

$$\text{Pump pressure} = \text{needed pressure} + \text{height loss} + \text{friction loss}$$

2. Foreign materials such as dirt, gravel, iron rust, etc. may go into a fire hydrant. Before connecting a hose, open a fire hydrant and discharge water in order to remove foreign materials.
3. When using water from a fire hydrant, set a mediation metal to the suction port of the pump. (Between a delivery hose and the pump)
4. Set the discharge valve handle of the pump to the full open position.
5. Gradually open the fire hydrant on-off valve. However, check the water pressure from fire hydrant with suction pressure gauge on the pump and adjust the opening of fire hydrant on-off valve, if necessary.



CAUTION

- **If the water pressure from a fire hydrant is higher than 0.6MPa, do not open the fire hydrant on-off valve more.**
- **If the water pressure from fire hydrant is higher than the required discharge pressure, it is not necessary to start the pump.**

6. If the water pressure from fire hydrant is insufficient, start the engine and adjust the discharge water pressure to the required level by operating the throttle lever. Stop increasing discharge pressure if the suction pressure gauge shows 0.1MPa (15psi) or below. If it does, stop increasing the pressure and keep the throttle lever as it is.
7. To end discharge water, turn the throttle lever to the low-pressure position firstly, then stop the engine and close the fire hydrant on-off valve.



CAUTION

- **Be sure not to close the discharge valve and nozzle of any pumps until all the pumps stopped and the fire hydrant on-off valve is closed.**

8. Set the discharge valve to the half-open position, and open all the drain valves to drain the remaining water in the pump as maintenance after operation.

9. PRIME AND DISCHARGE

Relay pumping operations



• In the case of relay pumping operations training in a flat place, if the number of extending hose is less than ten, use the safety nozzle attached.

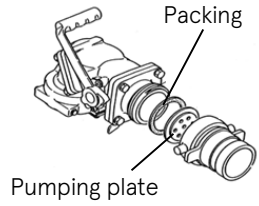

Description of relay pumping operation

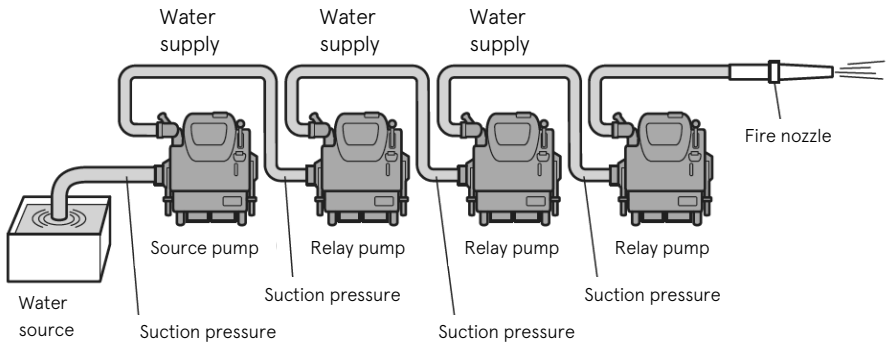
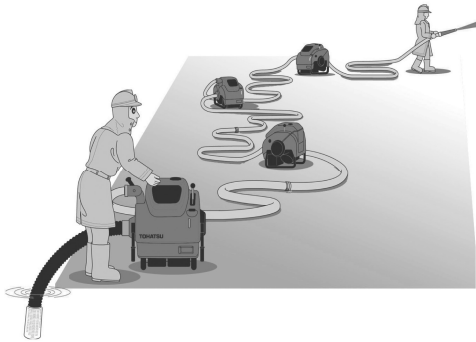

9. PRIME AND DISCHARGE

Preparation for operation



WARNING • Do not close the discharge valve of source pump, relay pumps and fire nozzle. If the discharge valves or nozzle are (is) closed, there will be a risk of damage to the pumps and hoses with excessive pressure or water hammer.

1. Decide how many relay pumps are needed in consideration of the distance and height between the water source and the fire ground.
2. Place the pumps according to the decision and connect the hoses.
3. Make sure that the discharge valves are open, including the fire nozzle.
4. Decide the discharge pressure of each pump in consideration of needed pressure for next pump (or fire nozzle) and the height loss and friction loss.

$$\text{Pump pressure} = \text{needed pressure} + \text{height loss} + \text{friction loss}$$

Start the Source Pump



WARNING • Once the water supply has started, keep supplying water until finished. If reduce or stop supplying water, overheat or cavitation may occur in the relay pumps.

1. Start the source pump. Refer to “Chapter 8. STARTING THE ENGINE”.
2. Start supplying water. Refer to “Chapter 9. PRIME AND DISCHARGE”.

Start the Relay Pump

1. Make sure that the discharge valve is opened and wait supplied water.
2. Check that the water was supplied from the source pump. At first, the hose swells due to air pressure. Step on the hose to judge whether the swelling of the hose is due to water or air.
3. Confirm that the water is supplied to the pump, read a pressure gauge. Start the engine if the pressure is lower than the required pressure. If the pressure is high enough, no need to start the engine.

9. PRIME AND DISCHARGE

4. Adjust the discharge pressure with throttle lever. The suction pressure decreases with opening up the throttle. Always confirm the pressure with the suction pressure gauge.
5. If the suction pressure drops below 0.1MPa (15 psi), order the operator of the former pump to increase the water pressure, and adjust the relay pump pressure by the throttle.
6. If the suction pressure rises, adjust the throttle again.

Start the Attack Pump

It is the same as the relay pump case.

Finish the relay Pumping Operation

1. Do not close the fire nozzle.
2. Stop the attack pump running first.
3. Stop the relay pump running in order from the pump near the nozzle.
4. Finally stop the source pump.



- **Do not touch the exhaust pipe and the muffler while the engine is running, and also do not touch if for 10 minutes more after the engine has been stopped.**
- **These parts are very hot and will cause severe burns.**



10. STOPPING THE ENGINE

Stop the engine

1. Return the throttle lever to "LOW pressure" side.

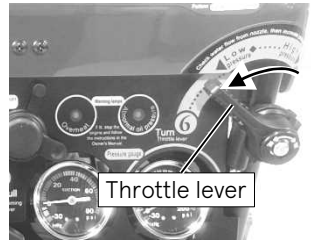

2. Close the discharge valves.

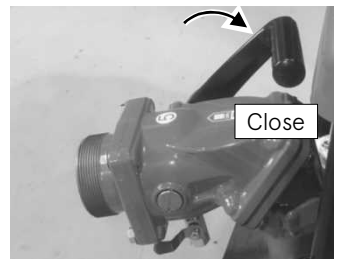

3. Stop the engine.

Turn the main switch to "STOP" position.

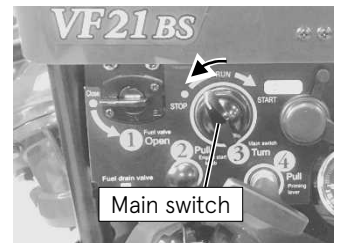

11. MAINTENANCE AFTER OPERATION

Maintenance after pumping seawater or foul water

After pumping seawater or foul water, the pump should be flushed out with fresh water immediately to prevent excessive corrosion.

And operate the vacuum pump for 5 seconds at low engine speed in order to clean the inside of the vacuum pump.

Drain water

(4 drain valves / operate at three locations.)

1. Open the drain valves and check the water in the pump has been completely drained.
2. Close the all drain valves for the next operation.

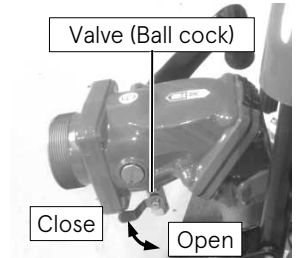
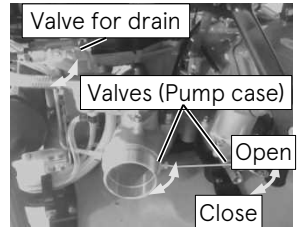

Suction performance check

1. Open the drain valves and check the water in the pump has been completely drained.
 2. Close all the drain valves and the suction port (with a cap, etc.).
- * Close the suction port not to leak air into the pump.

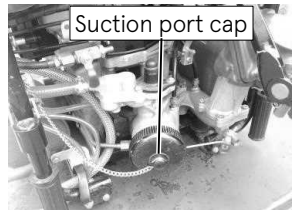

NOTE

- Prepare a suction cap that is suitable for the suction coupling.

11. MAINTENANCE AFTER OPERATION

3. Start the engine, and operate the priming lever with the throttle lever at the suction position to produce a vacuum.

*Priming (Vacuum) pump operating time: within 30 seconds.

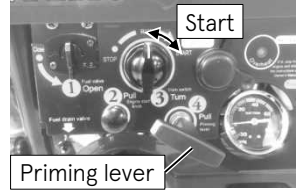

4. After a vacuum is produced, return the priming lever to the original position, and stop the engine.



5. Check that the vacuum pressure of the pressure gauge for suction is about -0.08 MPa (-12psi).

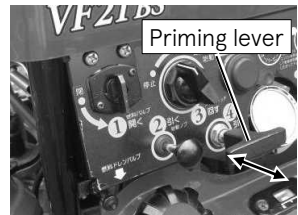

6. In order to check that there is no vacuum leak, leave the pump for 30 seconds and confirm that the pointer of the pressure gauge for suction keeps the same pressure indication.

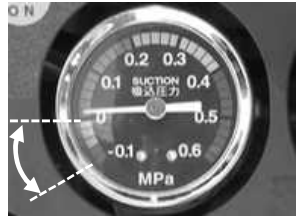

7. Open the drain valves slowly to expose it to the atmosphere, and check that the pointer of the pressure gauge for suction returns to "0".

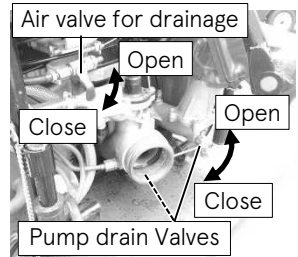

8. Close the drain valves.

11. MAINTENANCE AFTER OPERATION

Fuel and Oil Supply

Fuel

Fill fuel until the maximum level of the gauge indicator (red).



- **Wipe off fuel using a cloth or the other materials if there is fuel out of the fuel tank.**

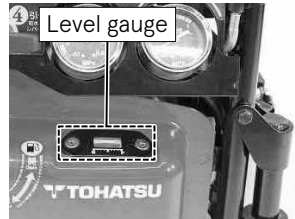

Engine oil

Fill the engine with 4-stroke engine oil.

API: SH, SJ, SL

SAE: 10W-30/40

NOTE

- A new pump is not filled with engine oil. Before using the pump, fill it with the designated amount of engine oil.
- How to change the oil is shown below.
 1. Set the carrying handles of the suction water side as shown in the figure, tilt the pump
 2. Put the pan for the waste oil under the drain hole.
 3. Remove the drain bolt to drain out the oil.
 4. Tighten the drain bolt with a predetermined torque.

Be sure to use oil having suitable viscosity for the external air temperature of the area where the pump is used.

- * It is possible to check the amount and cleanliness of the engine oil through the window which is fixed in the oil pan.

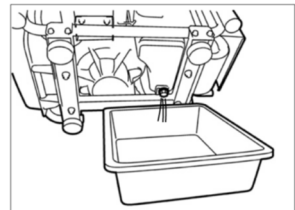
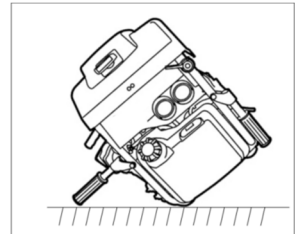
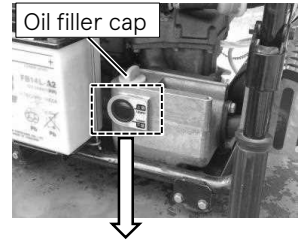

11. MAINTENANCE AFTER OPERATION

Cleaning strainer for prime

Remove the strainer cap, and remove the strainer. Clean the strainer with fresh water. If the strainer is dirty with dust, etc., vacuum performance efficiency will be reduced.

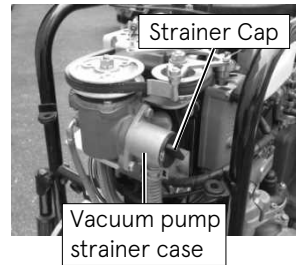

Charging battery



- Read the safety instructions carefully and/or warnings before using or charging the batteries.
- Hydrogen gas form the battery is explosive.
- Keep battery away from flame and spark.
- Charge the battery in well ventilated area.
- Do not charge battery in unventilated area.



- Read the cautions attached to the battery carefully before use.

Be sure to charge the battery after each operation.

11. MAINTENANCE AFTER OPERATION

Battery charger

Read the instruction manual of the battery charger before use.

*The battery charger is packed with the instruction manual.

Use an automatic battery charger.



CAUTION

- **Use a battery charger that has an overcharge prevention function.**
- **Read the instruction manual of the battery charger before charging a battery.**
- **Automatic charger should be kept in a dry and well-ventilated place.**

1. Confirm that there is no dirt, no slack, no backlash of the terminal.
2. Confirm the quantity of liquid in the battery.
(The shield type is excluded)
3. Turn the main switch to the “STOP” position.
4. Plug the charging plug to the battery charger connector.
5. Insert the input plug to household power supply.
6. Confirm the battery charging status referring the battery instruction manual.
7. Disconnect the battery charger when using the pump.

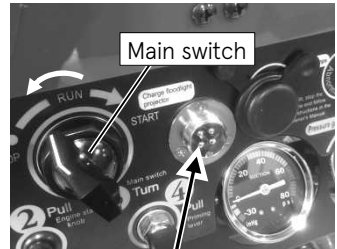

NOTE

- If the main switch is on, the battery cannot be charged.
- Pull out the battery charger plug from the socket when you use or move the pump.

12. MAINTENANCE IN COLD CONDITION

Battery



WARNING

- Hydrogen gas from the battery is explosive.
- Keep battery away from flame and sparks.
- Charge the battery in a well-ventilated area.
- Do not charge battery in unventilated area.



CAUTION

- The battery capacity must be 12 V-12 Ah/10 HR.
- Read the instruction (caution) of the battery carefully before use.

In the case of Opening type battery

- Battery fluid decreased also in compensation charge state.
- Inspect the battery liquid level once a month. If battery liquid is "LOW LEVEL", supplement steaming water (replenisher) to "UPPER LEVEL".
- To know the exact state to charge, measure specific gravity of the battery liquid by an aerometer. The specific gravity of the full charge is 1.28(20°C conversion).
- The outer surface of the battery should be kept always clean.
- The battery life is normally 2 years even if the battery is used properly.
- Replace with new battery every 2 years checking the deterioration of the charging performance.
- When connecting battery wires, attach the positive (+) battery wire first.
(When disconnecting battery, remove the negative (-) wire first.)
- Hydrogen gas released from the battery can cause damage and severe burns of the clothes and skin.



UPPER LEVEL
LOWER LEVEL

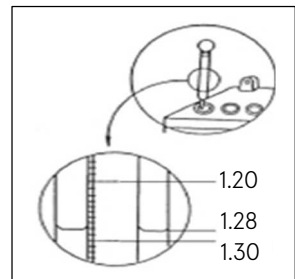

12. MAINTENANCE IN COLD CONDITION

In the case of Maintenance-free battery

CAUTION

- In the case of a maintenance-free type battery, it is not required to replenish the distilled water. After starting to use it, don't open the battery caps later.
- Replace with new battery every 2 years.
- Do not replenish distilled water and/or replenisher to a maintenance-free battery.

Infuse anti-freezing fluid

CAUTION

- If the temperature around the pump could be subzero, the inside of the pump can be frozen. In this case, the water pump or the vacuum pump may not be worked. And the pump unit including engine and muffler may be damaged or broken.
- In order to prevent internal corrosion and freeze damage by the water in the pump, drain all the water from the pump after each use.
- After draining the water, put antifreeze fluid into the pump and vacuum pump.

Pump unit

1. Open the drain valves and the air valve for drain.
Drain all the water from the pump.
2. Close the drain valves.

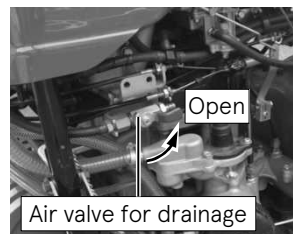
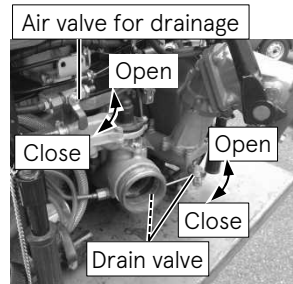

12. MAINTENANCE IN COLD CONDITION

3. Close suction port (with a cap, etc.). (Keep the air valve for drainage opened)

*Close the suction port not to leak air into the pump.



4. Insert the plastic tube (vinyl) to the air valve.

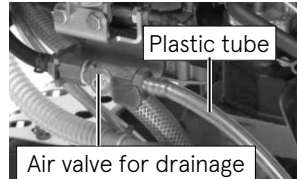

5. Insert the plastic tube in the container filled with antifreeze fluid.

(180ml/0.04USG - 200ml/0.05 USG)



6. Turn the throttle lever at "Low pressure" side.

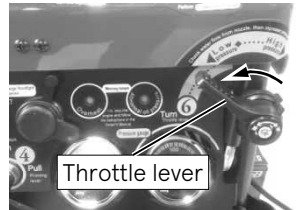

7. Turn on the main switch. (Turn the main switch to "RUN") position.

Turn the main switch to "START" position.

Release the main switch immediately after the engine starts.

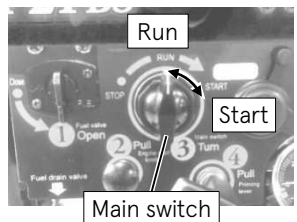

12. MAINTENANCE IN COLD CONDITION

8. After starting the engine, suck antifreeze fluid by pull the priming lever.

NOTE

- Even if all the anti-freezing fluid sucked up, continue pulling a priming lever for 30 seconds.

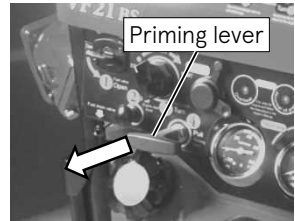

9. Turn the main switch to "STOP" position, and close the air valve for drainage.

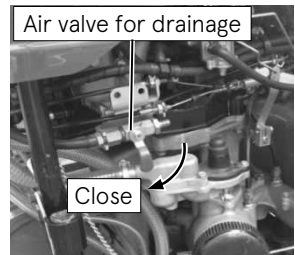
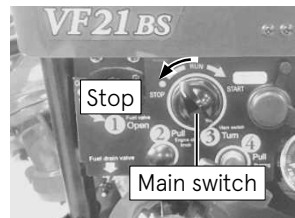

Discharge valve

- Fill antifreeze fluid the seal area of the discharge valve.
To use a long nozzle containing is helpful when pouring antifreeze fluid.

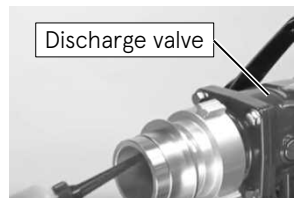

13. USE OF ACCESSORY

Battery

Battery performance will degrade if the temperature goes down. Also, if the specific gravity is low, the battery may freeze.

⚠ WARNING

- Hydrogen gas from the battery is explosive.
- Keep battery away from flame and sparks.
- Hydrogen gas emitted from the battery will also cause severe burns to skin and damage.
- Charge battery in well ventilated area.
- Do not charge a battery in unventilated area.

⚠ CAUTION

- Read the instructions attached to the battery carefully before use.
- When charging batteries, be sure to use an automatic battery charger.
- Use an automatic battery charger that matches the battery specifications.
- Use of a mismatched automatic battery charger may cause the battery to explode.
- Keep the battery surface clean.
- Battery life is normally 2~3 years even if battery is used properly.
- Replace with new battery every 2 ~ 3 years checking the deterioration of the charging performance.
- When connecting battery cables, positive (+) lead shall be connected first.
- (When disconnecting battery, remove the negative (-) lead first.)
- Battery electrolyte is a very caustic acid, which will cause severe burns to your skin and damage to clothing.



13. USE OF ACCESSORY

Pumping plate



- **When the fire pump is used for a water lifting device, such as pumping water out of a cellar. Install the pumping plate* with holes in between the discharge port adapter and the bracket packing to avoid the pump cavitation which may cause damages to the pump.**

Pumping plate is the standard accessory.

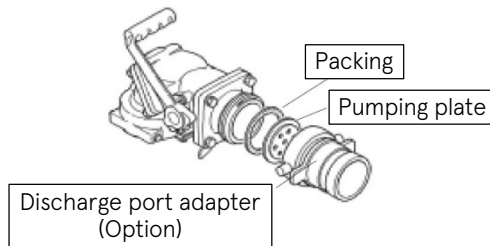

When using the pump without a nozzle, put the pumping plate between the discharge port adaptor and the packing as shown in the figures above.

NOTE

- Put the pumping plate as the figure shown above, so that pressure for cooling water in the pump is maintained at certain level. Then you can use the pump without a discharge nozzle.

14. PERIODICAL INSPECTION

Description		Inspection intervals				Inspection items	Measure
		After each operation	50 hr 0.5 year or	1 year or 100 hr	3 years or 300 hr		
Fuel system	Fuel		●			Impurities (ie. Water and / or waste)	Clean out.*1
		●				Level	Refuel.
			●			Preservation period 6 months or more.	Replace.*1
			●			Degradation (ie. Stink or color)	Replace.*1
	Strainer		●			Impurities(if water and/or waste has accumulated)	Clean out.*1
	Fuel hose		●			Curling, crack, leakage, connection	Replace.*1
Ignition	Spark plug		●			Fouling, wear, gap	Clean out or replace.
Engine	Cranking				●	Is not locked Poor compression pressure	Replace parts if necessary. *1
	Engine oil	●				Oil level	Refill the same oil.
Starting system	Starter rope		●			Wear, damage	Replace. *1

14. PERIODICAL INSPECTION

Description		Inspection intervals				Inspection items	Measure
		After each operation	50 hr	0.5 year or 100 hr	1 year or 300 hr		
Starting system	Battery	●				Voltage measure	Charge.
					●	Period of use	Replace. *1*2
Priming system	V-Belt			●		Wear, crack, belt, tension	Replace. *1
	Strainer	●				Clogging or broken mesh	Clean or replace.
	Primer	●				Is not locked. Check performance (-0.08 MPa/-12psi)	Replace parts if necessary.*1
		●				Air check	Check pump unit if necessary.*1
Pump unit	Closed discharge valves operation after priming water.		●			Check performance (1 MPa/145psi)	Replace parts if necessary.*1
Discharge	Valve			●		Vacuum leakage	Replace parts if necessary.*1
All parts					●		Replace parts if necessary.*1

*1 Ask our customer service staff to replace the parts.

*2  **WARNING** • Batteries that have been used for more than three years may explode if charged.

15. SERVICE AND MAINTENANCE

General

Servicing and maintenance of this fire pump must only be carried out by personnel who have professional related knowledge and who are familiar with this fire pump and regulations regarding safety and accident prevention.

Before starting maintenance work:

- Stop the engine.
- Disconnect the negative terminal of the battery.
- Place the pump on a level ground.



Safety devices



- **After safety or protective devices have been disassembled as part of servicing and maintenance work, install them back to their original locations as soon as possible, making sure that they run normally without problems.**

Genuine parts

When replacing parts as part of servicing and maintenance of the fire pump, use only Tohatsu genuine parts.

If genuine Tohatsu parts and accessories are not used, it may adversely affect the function and safety of the fire pump. Therefore, for safety reasons, use only Tohatsu genuine parts. Tohatsu bears no responsibility for any personal injuries or equipment damages that may result from use of parts or accessories obtained from outside sources.



Environmental protection measures

Dispose of oil, fuel, batteries, etc. according to relevant environmental laws in the region.

Do not dump to nature or sewerage.



Waste

When discarding parts, go waste in accordance with environmental laws in the region procedure.



15. SERVICE AND MAINTENANCE

Opening the cowl

- When removing or attaching top cowl, turn the throttle lever to “High pressure” side.
 - *The engine has to be stopped.



- Remove the rear hook from the hole, and remove the top cowl while taking care not to give damage with the recoil starter handle.

NOTE

- It is necessary to remove top cowl when removing spark plug.

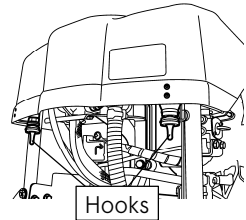

Assembling cowl

After putting recoil starter handle through top cowl hole, put front latch into hole of control panel, and then, fit rear hook into hole.

NOTE

- Pay attention to have the starter handle for manual starting go through the window at the front upper side of the cowl.

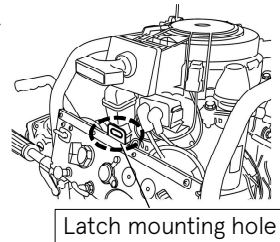

15. SERVICE AND MAINTENANCE

Vacuum pump strainer

Maintenance

NOTE

- Incorrect installation of the strainer may cause a vacuum leak. Be sure to install the strainer correctly.

Refer to “Chapter 11 MAINTENANCE AFTER OPERATION”

1. Remove the strainer cap, and remove the strainer.
2. Wash the strainer with fresh water.
3. After washing, assemble the strainer.
Tighten with the strainer cap.

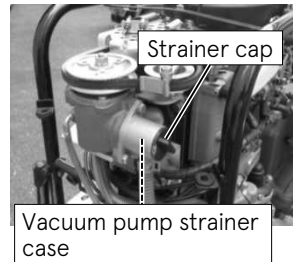

Engine oil

Check the oil level

**CAUTION**

- **Confirm the filler cap closed tightly each time, whenever you check the oil level.**

Check the oil level after each operation.

1. Place the pump in a horizontal location.
2. Check the oil level.
3. Refill the oil until the “UPPER” level.

NOTE

- 4-stroke engine oil
API: SH, SJ, SL
SAE: 10W-30/40

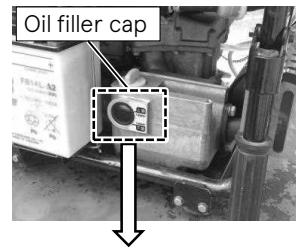

15. SERVICE AND MAINTENANCE

Vacuum pump V belt

Check the V belt every year or every 100 hours operating time.

V belt size: M-23

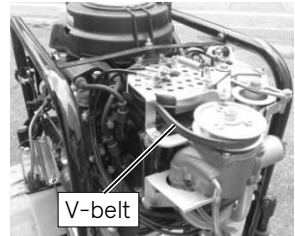

Spark plug

Check the spark plugs.

1. Remove the plug cap, and remove the plug.
2. Use a wire brush or spark plug cleaner, clean the electrode of the spark plug.
3. Check the spark plug for excessive carbon deposits, electrode erosion and check the washer for damage.



4. Measure the spark plug gap. If the gap is out of specification, replace the spark plug with the specified spark plug.

If necessary, adjust the gap to the specification.

- Spark plug gap[Ⓐ] : (0.8 ~ 0.9mm / 0.03 ~ 0.04in)
- Spark plug : DCPR6E (NGK)

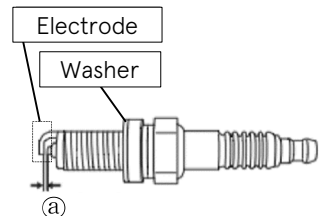

5. Assemble the spark plug as far as [Ⓑ] by hand. Tighten the plug further to the specified torque using a plug wrench. ([Ⓒ])

- tightening torque : 18 Nm[1.8 kgf-m]

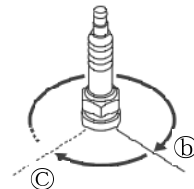

15. SERVICE AND MAINTENANCE

Battery

General safety information

Follow the safety instructions on the battery.

When charging a battery, a highly explosive oxyhydrogen gas mixture is produced.

Do not charge a battery in a poorly ventilated place.

Do not smoke near the battery.

⚠ DANGER • **Danger of injury due to caustic substances of battery**

- Always wear protective clothing.
- Always wear protective gloves.
- Always wear protective glasses.
- Do not tip the battery, acid would come out through the air vents.

Disposal

Disused batteries should be disposed of according to local laws or regulations.

After each operation of the battery, check the voltage.
Replace the battery if necessary.

Disconnect the negative terminal of the battery cable first, and disconnect the positive terminal.

- ⚠ CAUTION** • **There is a risk of injury.**
- **When handing the battery, be sure to wear safety glasses and protective gloves.**



15. SERVICE AND MAINTENANCE

Electric equipment

- Only expert electricians or trained staff members should handle the electrical equipment.
- Be sure to disconnect the battery cables before handling electrical equipment.
- Disconnect the negative terminal first, and disconnect the positive terminal.
- When connecting battery cables, connect the positive terminal first, then after connect the negative terminal.
- Use the fuse with the same current rating (ampere) as that of the installed fuse. Using a fuse that has excessive high resistance may result in electrical equipment failures.

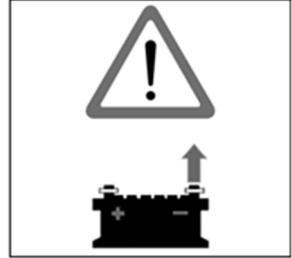

Fuse

- Security fuses are installed in electrical circuits used in electrical equipment.
- Before replacing the fuse, isolate the cause of the short circuit, and take the appropriate action.
- After the appropriate action has been taken, replace the fuse with a new one.
- Prepare the spare fuse at all times for emergency.

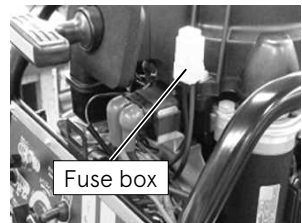

15. SERVICE AND MAINTENANCE

Suction performance check



- **Limit continuous operating time of the vacuum pump to 30 seconds or less.**
- **Operating the pump for 30 seconds or more continuously may cause overheat of the engine, then wait until it cools down, or discharge water to cool down the engine.**

* The water discharge operation allows the cooling water to circulate to the engine and cool it.

1. Open the drain valves and check the water in the pump has been completely drained.
2. Close all the drain valves and close suction port (with a cap, etc.).
*Close the suction port not to leak air into the pump.



3. Start the engine, and operate the priming lever (Within 30 seconds). Turn the throttle lever generating vacuum if needed.

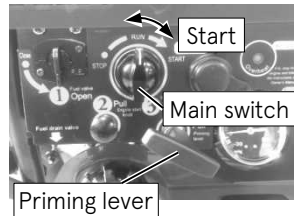

4. After the vacuum is generated enough (about -0.08 MPa (-12psi)), immediately return the priming lever to the original position, and stop the engine.

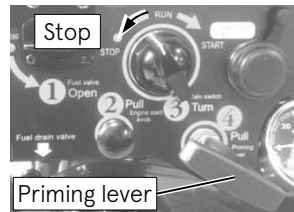

15. SERVICE AND MAINTENANCE

5. Check that the vacuum pressure of the pressure gauge for suction is about -0.08 MPa (-12 psi).

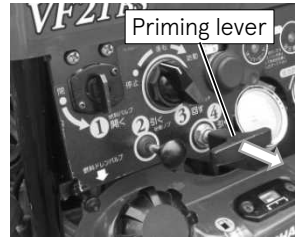

6. In order to check that there is no vacuum leak, leave it for 30 seconds and confirm that the pointer of the pressure gauge for suction keeps the same pressure indication. *1

7. Open the drain valves slowly to expose it to the atmosphere, and check that the pointer of the pressure gauge for suction returns to "0".

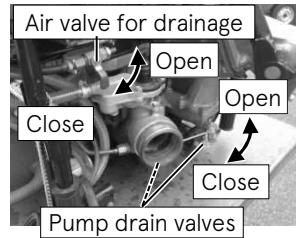

8. Close the drain valves.

*1 Vacuum leak check

If the vacuum leak is found, isolate the cause referring to "Chapter 16 TROUBLESHOOTING". Then take an appropriate action and check the vacuum leak again.

15. SERVICE AND MAINTENANCE

Water leak check

1. Attach the suction hose to the suction port.

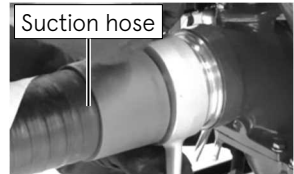

2. Place the end of the hose into the water more than 300mm (11.8in) deep from the water surface, and then close the discharge valve handle.



3. Start the engine, and pull the priming lever.



4. Operate the throttle lever to raise the pump pressure almost to 1MPa (145psi), and then check for water leaks from each part of the pump and the cooling water piping.

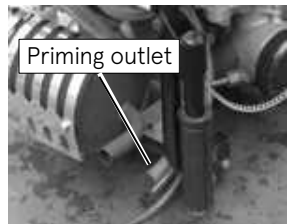

If a vacuum leak is found, isolate the cause referring to “Chapter 16 TROUBLESHOOTING”. Then, take the appropriate action and check the water leak again.

16. TROUBLESHOOTING

Typical causes of engine troubles are listed in the following table.

Trouble	Cause												Action								
		Battery charging failure	Starter motor doesn't work	Engine start failure	Engine stumble or stall	Rough idling	Idling revolution is too high	Poor acceleration	Engine over-revolution	Engine overheating	Engine seizing	Vacuum pressure defective		Air leaking	Water suction failure	Water suction failure	Insufficient water discharge	Insufficient water discharge	Insufficient water discharge	Warning lamp flashing	Floodlight, Gauge lamp, Hour meter, Warning lamp do not work
Fuel and lubrication	Fuel shortage			●	●			●											●		Refuel
	Deterioration of fuel			●	●	●		●		●									●		Replace with new fuel.
	Fuel tank air vent clogging			●	●	●		●		●									●		Clean out clogging.
	Fuel filter clogging			●	●	●		●		●									●		Clean out clogging.
	Fuel pump failure			●	●	●		●		●									●		Replace.
	Fuel pipe kink or snap			●	●	●		●		●									●		Fix pipe kink or snap.
Electrical	Spark plug cap comes off			●	●	●		●											●		Plug in surely.
	Use of unspecified spark plug			●	●	●		●		●	●								●		Replace with specified spark plug.
	Spark plug fouling (No spark or weak spark)			●	●	●		●											●		Clean or replace with specified spark plug.
	Battery loose connection, terminal corrosion or expired	●	●																	●	Clean terminal and/ or tighten a terminal screw. If necessary replace.
	Battery charger defective	●																			Check 7.5A fuse and/or Battery charger. Replace if necessary.
	7.5A fuse blown	●																		●	Replace with spare fuse. When the blowout of the fuse happens repeatedly, check a cause.

16. TROUBLESHOOTING

Trouble	Cause									Action								
		Insufficient water discharge		Water suction failure		Air leaking	Vacuum pressure defective	Engine seizing	Engine overheat	Engine over-revolution	Poor acceleration	Idling revolution is too high	Rough idling	Engine stumble or stall	Engine start failure	Starter motor doesn't work	Battery charging failure	
																		Check the terminals, cords and screws. If necessary, replace part.
			●														●	Check input of starter solenoid. (Equal to control panel output.) Replace parts if necessary.
																		Correct or replace.
																		Clean out.
																		Make it pump location to nearer and lower position.
										●								Put the end of suction hose below 30cm of the water surface.
											●							Clean out a gasket and tighten securely. Replace a gasket if necessary.

16. TROUBLESHOOTING

Trouble		Cause		Action			
Warning lamp flashing	Floodlight, Gauge lamp, Hour meter, Warning lamp do not work						
		Insufficient water discharge	Caused by Engine unit				
			Caused by Playpipe				
			Caused by Pump unit				
		Caused by Suction					
		Water suction failure		●	●	Clean out.	
		Air leaking					
		Vacuum pressure defective		●	●	Repair or replace.	
		Engine seizing					
		Engine overheat					
		Engine over-revolution					
		Poor acceleration					
		Idling revolution is too high					
		Rough idling					
		Engine stumble or stall					
Engine start failure							
Starter motor doesn't work							
Battery charging failure							
Suction	Suction hose strainer clogged with dead leaf or waste etc.		●	●	Clean out.		
	Suction hose cracking or lining peeling off		●	●	Repair or replace.		
Primer	Vacuum pipe loose or cracking		●	●	Tighten securely a clump of vacuum pipe or replace.		
	Strainer cap loose or O-ring failure.		●	●	Tighten securely or replace.		
	V belt damaged or worn.		●	●	Replace.		
	Vacuum pump rotor shaft seizing		●		Repair or replace.		
	Vane, side plate worn or damaged		●	●	Replace.		
Water stop Valve	Water stop valve contamination.		●	●	Clean out.		
	Water stop valve diaphragm failure.		●	●	Replace.		

16. TROUBLESHOOTING

Trouble	Cause	Action																					
		Warning lamp flashing	Floodlight Gauge lamp, Hour meter, Warning lamp do not work	Insufficient water discharge	Caused by Engine unit	Caused by Playpipe	Caused by Pump unit	Caused by Suction	Water suction failure	Air leaking	Vacuum pressure defective	Engine seizing	Engine overheat	Engine over-revolution	Poor acceleration	Idling revolution is too high	Rough idling	Engine stumble or stall	Engine start failure	Starter motor doesn't work	Battery charging failure		
Pump	Drain valves are not closed							●	●	●												Close securely.	
	Suction port strainer clogged with dead leaf or waste etc.										●	●										Clean out.	
	Discharge valve imperfect open												●									Open securely.	
	Gauge pipe connector loose or gasket defective									●	●											Tighten securely. Replace gasket if necessary.	
	Pump cover bolts loose								●	●	●											Tighten securely.	
	Pump cover O-ring degradation									●	●												Clean out or replace.
	Impeller or guide vane caught a stone or damaged												●										Clean or replace.
	Mechanical seal damaged									●	●												Replace.
Nozzle	Discharge nozzle diameter too large										●	●										Change a nozzle for suitable size or incorporate safety nozzle.	
	Spray nozzle Clogged																						Clean out.
Governor	Governor adjustment out of specified												●	●								Readjust it securely.	
	Governor link disconnected														●	●	●	●	●				Attach it securely.

17. APPENDIX

Tightening torque specifications

		M3	M4	M5	M6	M8	M10
Standard Bolt	N·m	0.7	1.6	4	6	13	27
	lb·ft	0.5	1.2	3	4	9	20
	kgf·m	0.07	0.16	0.4	0.6	1.3	2.7
Heat Treated Bolt	N·m				9	24	47
	lb·ft	-	-	-	7	17	34
	kgf·m				0.9	2.4	4.7

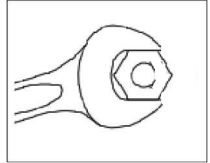

18. TOOL AND STANDARD ACCESSORY

Standard accessory

Description	Remarks	Quantity
Tool kit		1
• Tool kit bag		1
• Plug wrench		1
• Handle of plug wrench		1
Spark plug	DCPR6E	1
Pumping plate		1
Fuse *	7.5A	1
Vinyl pipe		1
Auto battery charger		1

*A spare fuse is in the fuse box attached to the pump.

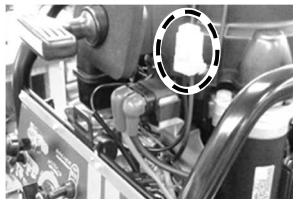

OWNER'S MANUAL

VF21BS

PORTABLE
FIRE PUMP

No.003-12067-4

TOHATSU CORPORATION

5-4, Azusawa 3-Chome, Itabashi-Ku
Tokyo 174-0051, Japan
Phone: +81-3-3966-3137